

Oil-Lubricated Compressors for Regenerative Cryocoolers Using an Elastic Membrane

E.C. Luo, Z.H. Wu, G.Y. Yu, J.Y. Hu, and W. Dai

Technical Institute of Physics and Chemistry
Chinese Academy of Sciences
Beijing 100080 China

ABSTRACT

Lubricated oil for moving parts is not allowed to go into thermodynamic components such as heat exchangers and regenerators because the lubricated oil will deteriorate the heat transfer performance and block flowing passages. To date, there has not been a easy, cost-effective and reliable solution to solve the problem of lubricated-oil separation in the oscillating systems. The authors propose an innovative way to attack this difficult problem. The proposed solution is based on the fact that the oscillating flow never flows through every thermodynamic component. The mechanical work for the cold box is transported in the form of an acoustical wave, and the flow particles only oscillate nearby their counterbalanced positions. Accordingly, an elastic rubber membrane can be used to fulfill two important functions: acoustical power transportation and lubricated oil separation. Some important rules and considerations for designing such a device are given. The operating schematics of two types of oil-lubricated compressors are proposed; corresponding valveless oil-lubricated compressors and valved oil-lubricated compressors. In addition, three compressors are modified to drive a two-staged pulse tube refrigerator, a moving-plug pulse tube refrigerator and a four-valve pulse tube refrigerator. The preliminary experiments show that the solution could provide a realizable pressure wave generator by using a readily available commercial oil-lubricated compressors and a simple elastic membrane.

INTRODUCTION

Almost all regenerative cryocoolers operate on oscillating pressure of compressible gas. Either a valveless compressor or a valved compressor with a switching valve can generate an oscillating pressure.

In general, the valveless compressor refers to a reciprocating piston compressor which produces oscillating pressure by moving a piston inside a cylinder backward and forward. Commonly, the reciprocating piston is driven by a rotating motor through an assembly of a crankshaft and a connecting rod. Thus, there must be sliding and rotating frictions existing in many locations of the reciprocating compressor. To have high reliability, such reciprocating piston compressors should use lubricated oils to decrease friction loss. However, a regenerative cryocooler working with gaseous substance (e.g., helium) can not allow the lubricated oil to enter into its cold box; otherwise, the lubricating oil will solidify and block the flow passages or will contaminate heat transfer sur-

faces. In past decades, numerous efforts have been made to solve oil separation of the reciprocating compressor, but it seemed that previous techniques were not very effective or cost-effective. Thus, oilless reciprocating compressors have been studied and developed for years, and their reliability has been improved by using more advanced manufacturing techniques and materials. However, the life time of such oilless reciprocating compressors is still limited to several thousands of hours. In recent years, the linear compressor has been widely studied and developed. However, no large-scale commercial products can be available yet for different applications and they are too expensive at present time.

Valved compressors can also provide oscillating flow and pressure wave by using a switching valve. Indeed, there are huge resources of valved compressors such as valved reciprocating piston compressor, screw compressor, scroll compressor, centrifugal and so on. As the circulating flow in the compressor is steady in one direction, it is less difficult to solve its oil separation. Nevertheless, sophisticated measures should be taken to effectively prevent much oil from entering into the cryogenic box. Moreover, there is an additional drawback for the compressor systems: no oil can reach the switching valve so that the lifetime of the switching valve is limited, or the switching valve can not rotate with high speed because of dry friction inside the switching valve.

In the past few years, our research group has been concentrating on developing thermoacoustically driven cryocoolers. In searching for the DC-flow suppression measures of thermoacoustic Stirling heat engines, thermoacoustic Stirling refrigerators and the like, the authors of the paper has observed that an elastic membrane could not only effectively eliminate the DC flow but also transport pressure wave easily. Inspired by this observation, an elastic membrane is proposed for the oil separation of regenerative cryocoolers powered by conventional oil-lubricated valveless or valved compressor. If this idea is feasible, it will be very hopeful to develop a reliable and cost-effective cryocooler for wide applications.

BASIC OPERATING PRINCIPLE AND TWO CATEGORIES OF COMPRESSORS

According to the nature of flow, cryocoolers can be divided into two categories: recuperative and regenerative. In a recuperative cryocooler, its working fluid goes through each thermodynamic component. On the contrary, the working gas of a regenerative cryocooler never passes through each thermodynamic component. Instead, working gas parcels only oscillate nearby their counter-balance positions. In fact, the mechanical energy that is required for heat pumping in such a regenerative cryocooler transports in forms of acoustical waves. In terms of thermoacoustics, the mechanical energy is simply acoustical power, which is defined as the product of oscillating pressure and volume velocity. Once we recognize these critical points, it is straightforward to understand the reason why an elastic membrane can be used for regenerative cryocoolers.

Figure 1 is the schematic of valveless reciprocating compressor with an elastic membrane acting in place of the oil separator unit. In the front of the piston-cylinder assembly is the cavity where the elastic membrane is installed. Obviously, the lubricated oil can be totally separated. In

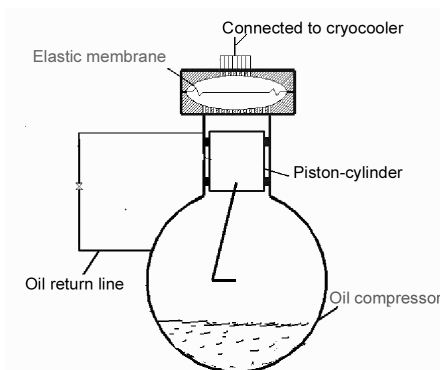

Figure 1. Schematic of valveless compressor

the meantime, the elastic membrane can transport acoustic energy without any difficulty. Certainly, such elastic membrane also have a problem with lifetime. But, unlike conventional diaphragm compressor where its membrane must tolerate large pressure difference between its two sides, the elastic membrane used here does not have this problem. In order to make the elastic membrane reliable, careful considerations are needed. The critical factors affecting the lifetime of the elastic membrane include the compatibility of membrane material with the lubricated oil and the working gas, the elastic characteristics of the membrane material, and the size of the membrane. First of all, the elastic membrane material should be compatible with the lubricated oil. In general, the fluorinated rubbers show good inertia when exposed to commonly-used lubricated oil. The thickness and diameter of the elastic membrane are two important parameters. According to our practice experience, the membrane with a thickness of 0.5 to 5 mm is preferable. The choice of the membrane diameter is related to many factors. At present, there is no specific criterion for the diameter. In general, the membrane diameter should be as large as possible if no significant negative effect is introduced. Moreover, in order to prevent the elastic membrane from occasional damage, the cavity for holding the elastic membrane can be manufactured with a special configuration. The cavity is formed by two half elliptical hollow balls with many circular channels as flow passages. In such a configuration, the separated oil can be easily returned by gravity or other additional oil returning devices.

Figure 2 is the schematic of a valved compressor system. The basic characteristics of this kind of compressors can produce steady flow with high and low pressure. These are referred to as valved compressors, but some of them are actually not equipped with single-direction valves as valved reciprocating compressors. The typical examples are screw compressor, scroll compressor, turbine compressor and centrifugal compressor. To be used as the pressure wave generator of a regenerative cryocoolers, a switching valve, which connects with the high and low pressure alternatively, can help to produce oscillating pressure for the cold box. There are many configurations of switching valves, which can be found elsewhere. Traditionally, there is a relatively sophisticated oil separator subsystem for working gas purification. In our modified oil-lubricated compressor, the oil separation assembly is installed right after the switching valve. The oil separator used here is simply a piece of elastic membrane. It is much simpler than a conventional oil separator. As used in a valveless compressor, the elastic membrane has similar requirements and a nearly identical configuration. The only difference between them is that the elastic membrane used in valveless compressor has the same frequency as the piston, whereas, the elastic membrane used in valved compressor has the same frequency as the switching valve. Understanding the difference can help to design an appropriately sized elastic membrane.

TEST OF MODIFIED OIL-LUBRICATED COMPRESSORS

Three conventional oil-lubricated compressors were modified to drive three types of regenerative refrigerators.^{1,2} Among them, two oil-lubricated compressors are semi-hermetic, reciprocating piston compressors with two cylinders. The third one is a hermetic compressor.

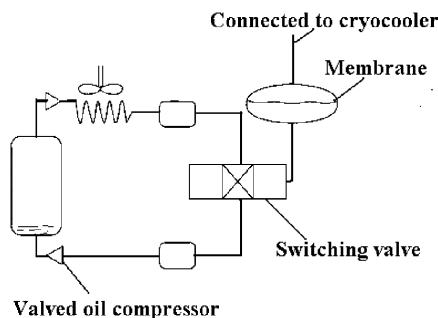

Figure 2. Valved oil-lubricated compressor with an elastic membrane as oil separator.

Compressor 1 for a Stirling-Type Pulse Tube Cryocooler

Compressor 1 is a reciprocating piston compressor with two cylinders. It is used for vapor compression refrigeration. Since a pulse tube cryocooler only needs one cylinder, the second piston was then taken off of the crankshaft. The disassembly process is not difficult because the compressor is a semi-hermetic one. The next step is to take off its single-direction valves. After this step, the compressor became a valveless reciprocating compressor with only one piston. To drive a pulse tube cryocooler, the lubricated oil should be separated. Thus, an oil separator unit with an elastic membrane was designed and fabricated based on the description above. The piston has a diameter of about 50 mm and a displacement of 40 mm. This corresponds to a swept of about 78.50 cm^3 . The nominal operating frequency is about 25 Hz. In the test, a frequency-regulator is used to adjust the operating frequency. Due to the limitation of a small mounting space, an elastic membrane assembly with a relatively small diameter is allowed to mount in between the piston-cylinder unit and the pulse tube cryocooler. The elastic membrane is made of fluorinated rubber with a diameter of about 80 mm and a thickness of about 1 mm. This diameter is not as large as we wanted. After the elastic membrane, there is circulating-water after-cooler. A copper pipe connects the compressor with the pulse tube cryocooler. Several piezoelectric pressure transducers are mounted in several locations to monitor operation of the membrane and the pulse tube cryocooler. The whole system works well. Figure 3 shows a pressure waveform at the inlet of the pulse tube cryocooler. From this figure, the compressor can provide a pressure ratio of above 1.50 for the pulse tube cryocooler. Actually, this pressure ratio is high enough for driving most pulse tube cryocoolers. Figure 4 gives the cooling down curve of the pulse tube cryocooler. One can see that after about one and half hours the pulse tube cryocooler achieved a non-load temperature of about 26.8 K. This test demonstrated that the modified compressor is workable. In fact, extensive cryocooler experiments have been performed with this modified oil-lubricated compressor. It really helps us to finish many cryocooler experiments. There was an observation of the membrane damage in some experiments, but in principle the membrane can be very reliable if a larger diameter membrane is used.

Compressor 2 for a Pulse-Type Stirling Refrigerator

Compressor 2 is the same type as compressor 1. In this test, a moving-plug pulse tube refrigerator was tested. It is well known that an integrated Stirling refrigerator needs two pistons. Thus, unlike the modification of compressor 1, no piston was taken out. However, the two pistons of the original compressor operate with a reversing phase. Thus, the crankshaft was re-machined to let the two pistons have a new phase difference. This phase difference was chosen based on the requirement of the Stirling refrigerator. Because the pulse tube is used as a thermal buffer, the displacer is moved to ambient surroundings. Similarly, all single-direction valves were taken out, and the compressor is then changed into a valveless reciprocating compressor. In order to prevent oil getting in the cold box, two elastic membrane units are necessary. The use of both pistons further limits the mounting space of the two membrane units. Compared with Compressor 1, the diameters of the two

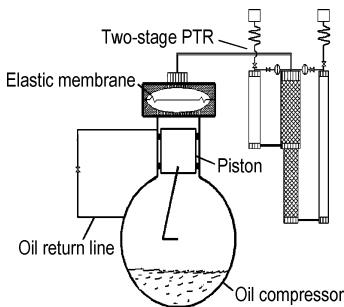

a) Flowing schematic

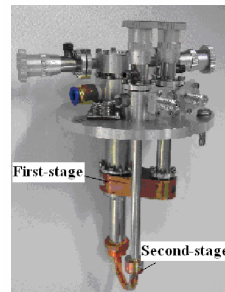

b) Two-stage PTR photo

Figure 3. The two-stage PTR driven by a modified valveless oil compressor.

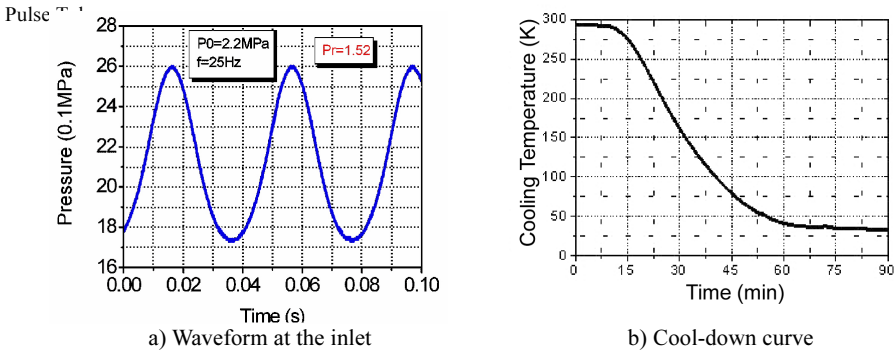

Figure 4. Performance of the two-stage PTR.

elastic membranes are smaller, which is not good for long-term operation. Figure 5a is the schematic for the entire system, and Fig. 5b is a photo of the refrigerator. Figure 6a shows the waveforms in the two elastic membrane cavities and Fig. 7b shows the load curve. The waveforms are not as good as the waveform measured in Compressor 1, and the reasons are still under investigation. With Compressor 2, the Stirling refrigerator achieved a cooling capacity of about 200 W at -80 °C at the expense of about 300 W of PV power.

Compressor 3 for a Four-Valve Pulse Tube Refrigerator

There are many valved compressors that can be used to develop a pressure wave generator using a switching valve. An additional benefit of using a valved compressor is to use a conventional condenser as the after-cooler. The additional benefit is more explicit for large-capacity applications in future. In this example, a four-valve pulse tube refrigerator is chosen and is expected to be developed as a low temperature freezer operating below -80 °C. The compressor assembly used here is a hermetic one, mainly including a valved reciprocating compressor, a conventional condenser cooled by a fan, and two high and low pressure reservoirs. To generate a pressure wave, a rotating switching valve is designed, fabricated and tested. Also, two elastic membrane units are designed and fabricated. Since there is a large mounting space, the two membranes have a diameter of more than 100 mm to make them as reliable as possible. Figure 7 is the schematic of the system, which is being fabricated.

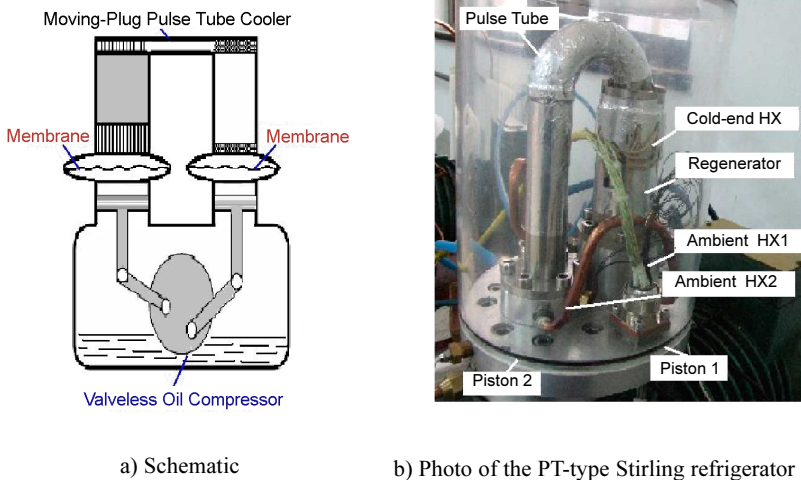

Figure 5. The PT-type of Stirling refrigerator driven by a modified valveless oil compressor.

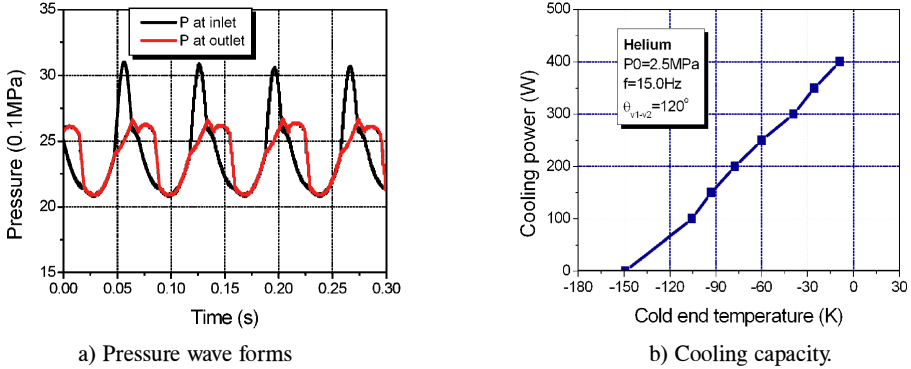

Figure 6. Performance of the PT-type Stirling refrigerator

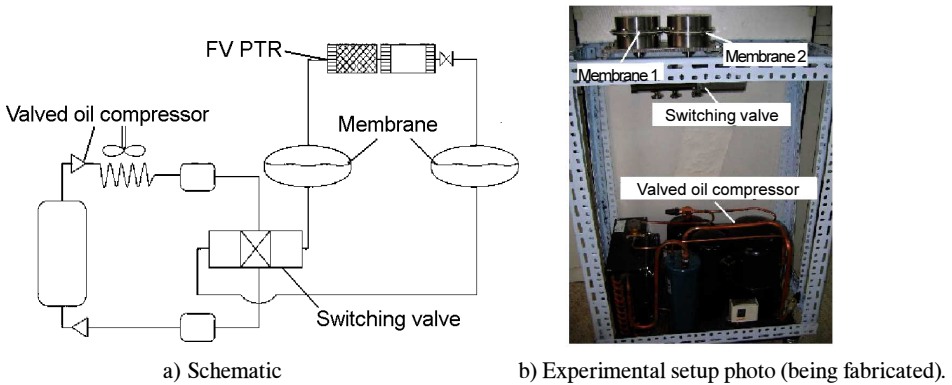

Figure 7. A four-valve PTR driven by a modified valved oil compressor

CONCLUSIONS

In this paper, an effective method is proposed to separate lubricated oil. By means of this method, extensive conventional compressors can be used. The oil separator uses an elastic membrane. It is extremely simple and inexpensive. To verify its feasibility, three compressors for driving different regenerative refrigerators or cryocoolers were modified and tested. These tests clearly demonstrated the proposed idea. To put this idea into practice, more research and development work needs to be conducted in the future.

ACKNOWLEDGMENT

This research is supported by the Natural Sciences Foundation of China (Grant No. 50536040).

REFERENCES

1. Luo, E.C., et al., "A New Pressure Wave Generator of Valveless Oil Compressor by using Elastic Membrane Assembly," *Chinese Patent and IPC* (2005, pending).
2. Luo E.C., et al., "Regenerative Machines by using Modified Oil Compressors," *Chinese Patent and IPC* (2005, pending).